

Article number: 5725027205

Description: NSK Cirkular flange unit UCFC205D1

Measures

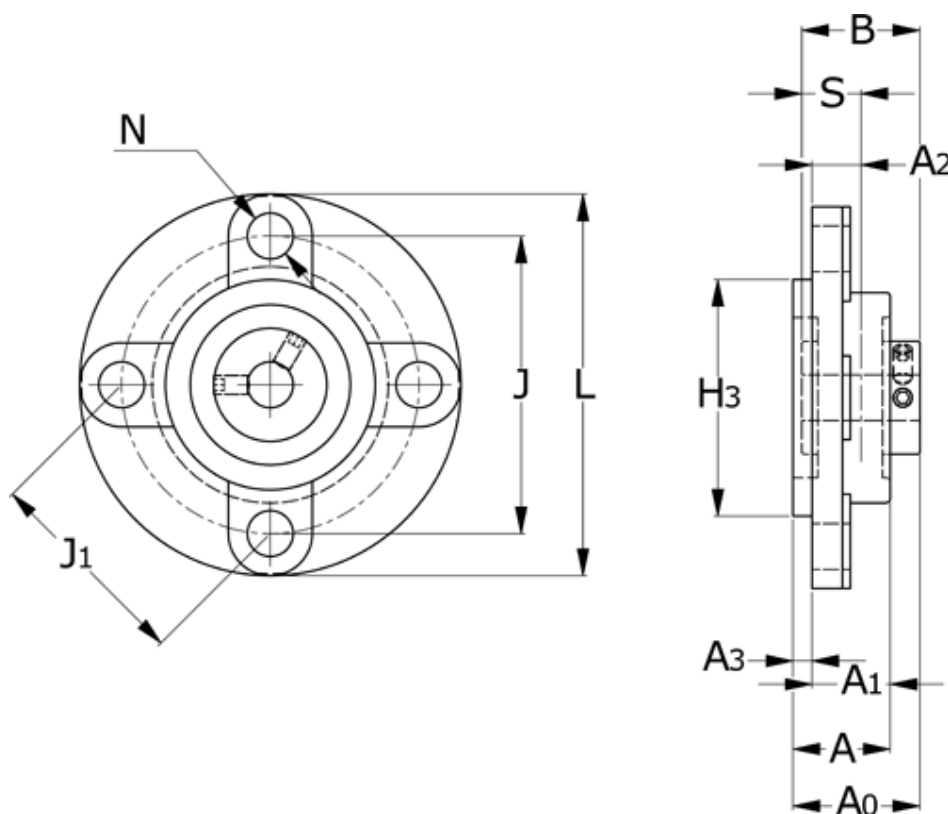

A = 27	J1 = 63.6
A0 = 35.8	L = 115
A1 = 21	N = 12
A2 = 10	S = 14.3
A3 = 6	Shaft = 25
B = 34.1	
H3 = 70	
J = 90	